

# Hisense

life reimagined

## USER'S OPERATION MANUAL

Before operating this unit, please read this manual thoroughly, and retain for future reference

HR6CDFF512S  
HR6CDFF512GB  
HR6CDFF512GW  
HR6CDFF509SW

English

## Contents

Safety and warning information.....	2	Helpful hints and tips.....	17
Installing your new appliance.....	7	Cleaning and care.....	18
Description of the appliance.....	9	Troubleshooting.....	19
Display controls.....	11	Disposal of the appliance.....	21
Using your appliance.....	13		



## Safety and warning information Contents

For your safety and correct usage, before installing and first using the appliance, read this user manual carefully, including its hints and warnings.

To avoid unnecessary mistakes and accidents, it is important to make sure that all people using the appliance are thoroughly familiar with its operation and safety features. Save these instructions and be sure that they remain with the appliance if it is moved or sold, so that anyone using it throughout its life will be properly informed on usage and safety notices.

For the safety of life and property, keep the precautions of these user's instructions as the manufacturer is not responsible for damages

caused by omission.

### **Safety for children and others who are vulnerable**

- This appliance can be used by children aged from 8 years and above, and persons with reduced physical, sensory or mental capabilities or lack of experience and knowledge if they have been given supervision or instruction concerning use of the appliance in a safe way and understand the hazards involved. Children shall not play with the appliance. Cleaning and user maintenance should not be carried out by children without supervision.
- Keep all packaging away from children as there is risk of suffocation.

- If you are discarding the appliance, pull the plug out of the socket, cut the connection cable (as close to the appliance as you can) and remove the door to prevent children from suffering an electric shock or from closing themselves inside.
- If this appliance, featuring a magnetic door seals, is to replace an older appliance having a spring lock (latch) on the door or lid, please make the spring lock unusable before you discard the old appliance. This will reduce the risk of trapping children or animals inside.

#### General safety



• **WARNING** — This appliance is designed to be used in domestic households and not intended for use in retail or commercial environments.

- **WARNING** — Do not store explosive substances such as aerosol cans with a flammable propellant in this appliance.
- **WARNING** — If the supply cord is damaged, it must be replaced by the manufacturer, its service agent or similarly qualified persons in order to avoid a hazard.
- **WARNING** — Keep ventilation openings in the appliance enclosure or in any built-in structure clear of obstruction.
- **WARNING** — Do not use mechanical devices or other means to accelerate the defrosting process, other than those recommended by the manufacturer.
- **WARNING** — Do not damage the refrigerant circuit.
- **WARNING** — Do not use electrical appliances inside the food storage compartments of the appliance, unless they are of the type recommended by the manufacturer.
- **WARNING** — The refrigerant and insulation are flammable.

When disposing of the appliance, do so only at an authorized waste disposal center. Do not expose to flame.

## Refrigerant

The refrigerant isobutene (R600a) is contained within the refrigerant circuit of the appliance. This is a natural gas with a high level of environmental compatibility, which is nevertheless flammable. During transportation and installation of the appliance, ensure that none of the components of the refrigerant circuit becomes damaged.

The refrigerant (R600a) is flammable.



### **Caution: risk of fire**

If the refrigerant circuit is damaged:

- Avoid naked flames and sources of ignition.
- Thoroughly ventilate the room in which the appliance is situated.

It is dangerous to alter the specifications or modify this product in any way.

Any damage to the cord may cause a shortcircuit, fire, and/or electric shock.



## **Electrical safety**

- 1.The power cord must not be lengthened.
- 2.Make sure that the power plug is not crushed or damaged. A crushed or damaged power plug may overheat and cause a fire.
- 3.Make sure that you can access the main plug of the appliance.
- 4.Do not pull the main cable.
- 5.If the power plug socket is loose, do not insert the power plug. There is a risk of electric shock or fire.
- 6.You must not operate the appliance without the interior lighting lamp cover.
- 7.The fridge should only be supplied with single phase alternating current of 220 ~ 240V / 50Hz . If the supply fluctuates outside this range an automatic A.C. voltage regulator of more than 350W should be used. The fridge should be plugged into an adequately earthed supply

---

## Daily use

- Do not store flammable gas or liquids in the appliance, there is a risk of explosion.
- Do not operate any electrical appliances in the appliance (e.g. electric ice cream makers, mixers etc.).
- When unplugging always pull the plug from the mains socket. Do not pull on the cable.
- Do not place hot items near the plastic components of this appliance.
- Do not place food products directly against the air outlet on the rear wall.
- Store pre-packed frozen food in accordance with the frozen food manufacturer's instructions.
- The manufacturer's storage recommendations should be strictly adhered to. Refer to relevant instructions for storage.
- Do not place carbonated or fizzy drinks in the freezer compartment as it creates pressure on the container, which may cause it to explode, resulting in damage to the appliance.
- Frozen food can cause frost burns if consumed straight from the freezer compartment.
- Do not place the appliance in direct sunlight.
- Keep burning candles, lamps and other items with naked flames away from the appliance
- The appliance is only intended for keeping food and/or beverages for normal household consumption as explained in this instruction booklet  
The appliance is heavy. Care should be taken when moving it.
- Do not remove nor touch items from the freezer compartment if your hands are damp/wet, as this could cause skin abrasions or frost/freezer burns.
- Never use the base, drawers, doors etc. to stand on or as supports.
- Frozen food must not be refrozen once it has been thawed out.

- 
- To avoid items falling and causing injury or damage to the appliance, do not overload the door racks or put too much food in the crisper drawers.

### **Caution!**

#### **Care and cleaning**

- Before performing maintenance, switch off the appliance and disconnect the mains plug from the mains socket.
- Do not clean the appliance with metal objects, steam cleaners, ethereal oils, organic solvents or abrasive cleansers.
- Do not use sharp objects to remove frost from the appliance. Use a plastic scraper.

#### **Installation Important!**

- For electrical connection carefully, follow the instructions given in this manual.  
Unpack the appliance and check for damage. Do not connect the appliance if it is damaged. Report possible damage immediately to your retailer. In this case, please retain packing.

- It is advisable to wait at least four hours before connecting the appliance to avoid damaging the compressor.
- Adequate air circulation should be provided around the appliance. To achieve sufficient ventilation. Please follow the instructions relevant to installation.
- Wherever possible the back of the product should not be too close to flammable materials as some components are hot in normal operation. The appliance must not be located close to radiators or cookers.
- Make sure that the mains plug is accessible following installation of the appliance.

#### **Service**

- This product must be serviced by an authorized Service Center or Service Agent, and only genuine spare parts must be used

## Service Note

This appliance employs Hydrocarbon Refrigerant type R600a.

It is hazardous for anyone other than an Authorized Service Person to service this appliance.

In Queensland the authorized Service Person **MUST** hold a Gas Work Authorization for hydrocarbon refrigerants to carry out servicing or repairs which involve removal of covers.

## Installing your new appliance

Before using the appliance for the first time, you should be informed of the following tips.

### Ventilation of appliance



In order to improve efficiency of the cooling system and save energy, it is necessary to maintain good ventilation around the appliance for the dissipation of heat. For this reason, sufficient clear space should be available around the refrigerator. Suggestion: It is advisable for there to be at least 100mm of space from the back to the wall, at least 300mm from its

top, at least 200mm from its side to the wall and a clear space in front to allow the doors to open 135°. As shown in following diagrams

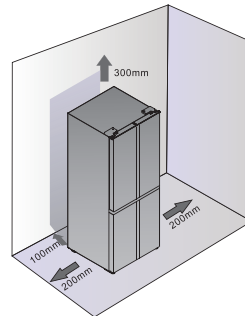

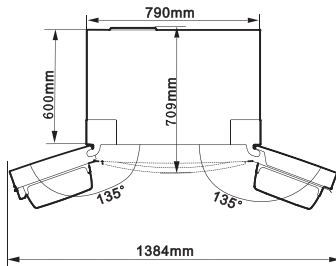

**Note:**

This appliance performs well within the climate class showed in the table below. It may not work properly if being left at a temperature above or below the indicated range for a long period.

Climate class	Ambient temperature
SN	+10°C to +32°C
N	+16°C to +32°C
ST	+16°C to +38°C
T	+16°C to +43°C

- Stand your appliance in a dry place to avoid high moisture.
- Keep the appliance out of direct sunlight, rain or frost. Stand the appliance away from heat sources such as stoves, fires or heaters.

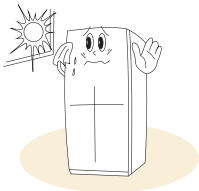

**Leveling of appliance**

- For sufficient leveling and air circulating in the lower rear section of the appliance, the bottom feet may need to be adjusted.
- To allow the doors to self-close, tilt the top backwards by about 10mm.

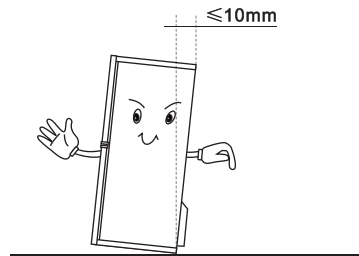

- You can adjust them manually by hand or by using a suitable spanner.

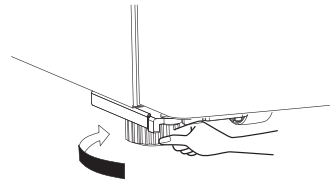



## Description of the appliance

### HR6CDDFF512S/GB/GW

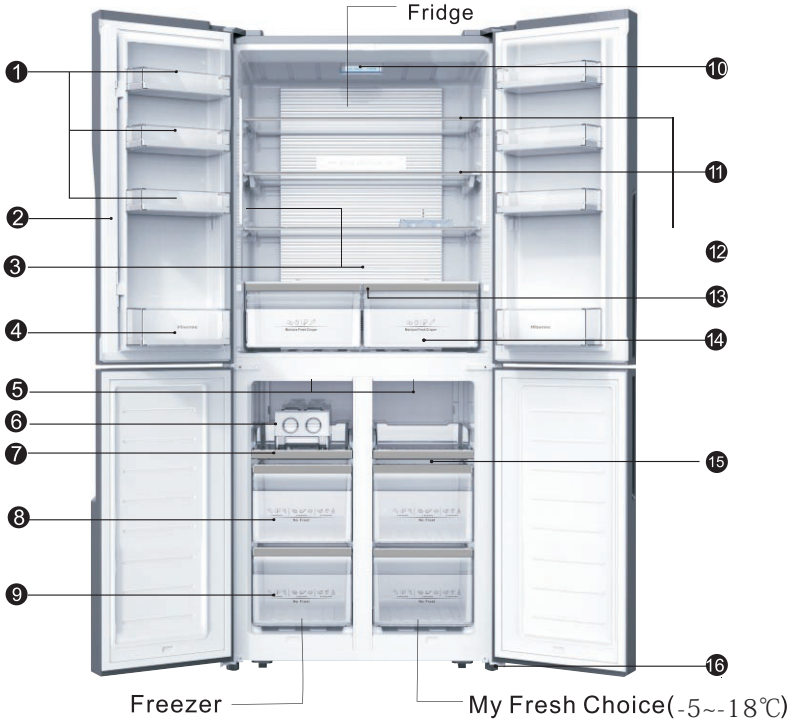

- |                            |   |
|----------------------------|---|
| ① Door basket              | ⑨ Bottom freezer drawer                 |
| ② Rotary separator         | ⑩ Decorative light                      |
| ③ Fridge LED light         | ⑪ Glass shelves                         |
| ④ Bottle basket            | ⑫ Egg tray (located in the plastic bag) |
| ⑤ Freezer LED light        | ⑬ Crisper cover                         |
| ⑥ Moveable twist ice-maker | ⑭ Fruit and vegetables crisper          |
| ⑦ Upper freezer tray       | ⑮ Glass plates                          |
| ⑧ Middle freezer drawer    | ⑯ Adjustable bottom feet                |

**Note:** Due to unceasing modification of our products, your refrigerator may be slightly different from this instruction manual, but its functions and using methods remain the same. To get more space in the freezer, you can remove drawers (except lower freezer drawer) and twistable ice tray.

## Description of the appliance

### HR6CDDFF509SW

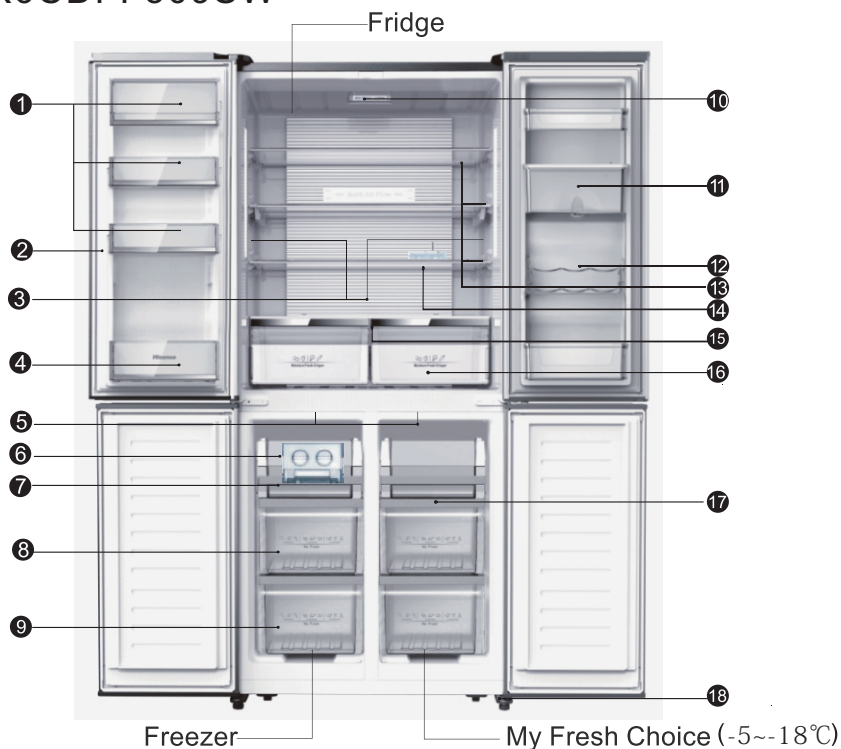







- |                            |  |
|----------------------------|--|
| ① Door basket              | ⑪ Water tank(with cover and knob)      |
| ② Rotary separator         | ⑫ Can rack                             |
| ③ Fridge LED light         | ⑬ Glass shelves                        |
| ④ Bottle basket            | ⑭ Egg tray(located in the plastic bag) |
| ⑤ FreezerLED light         | ⑮ Crisper cover                        |
| ⑥ Moveable twist ice-maker | ⑯ Fruit and vegetables crisper         |
| ⑦ Upper freezer tray       | ⑰ Glass plates                         |
| ⑧ Middle freezer drawer    | ⑱ Adjustable bottom feet               |
| ⑨ Lower freezer drawer     |  |
| ⑩ Decorative light         |  |

**Note:** Due to unceasing modification of our products, your refrigerator may be slightly different from this instruction manual, but its functions and using methods remain the same. To get more space in the freezer, you can remove drawers (except lower freezer drawer) and twistable ice tray.

## Display controls

Use your appliance according to the following control regulations, your appliance has the corresponding functions and modes as the control panels showed in the pictures below. When the appliance is powered on for the first time, the backlight of the icons on display panel starts working. If no buttons have been pressed and the doors are closed, the backlight will turn off.



-  Super cool
-  Super Freeze
-  Artificial intelligence
-  Energy Saving
-  Holiday
-  Lock

### Controlling the temperature

We recommend that when you start your refrigerator for the first time, the temperature for the refrigerator is set to 5°C, my fresh choice to -12°C and the freezer to -18°C. If you want to change the temperature, follow the instructions below.

Caution! When you set a temperature, you set an average temperature for the whole refrigerator cabinet.

Temperatures inside each compartment may vary from the temperature values displayed on the panel, depending on how much food you store and where you place them. Ambient temperature may also affect the actual temperature inside the appliance.

#### 1. Fridge

Press "Fridge" button repeatedly to set your desired fridge temperature between 8°C and 2°C, the temperature will decrease 1°C degrees with each press and the fridge temperature indicator will display corresponding value according to the following sequence.

8°C — 7°C — 6°C — 5°C  
2°C — 3°C — 4°C

#### 2. My Fresh Choice

Press "My Fresh Choice" button to set the two-star compartment temperature between -5°C and -18°C to suit your desired temperature, and the two-star compartment temperature indicator will display corresponding value according to the following sequence.

-12°C — -13°C — -14°C — -15°C — -16°C — -17°C — -18°C  
-11°C — -10°C — -9°C — -8°C — -7°C — -6°C — -5°C

#### 3. Freezer

Press "Freezer" button to set the freezer temperature between -15°C and -25°C to suit your desired temperature, and the freezer temperature indicator will display corresponding value according to the following sequence.

-18°C — -19°C — -20°C — -21°C — -22°C — -23°C  
-17°C — -16°C — -15°C — -25°C — -24°C

#### 4. Super Cool



Super Cool can refrigerate the food quicker and, keep food fresh for a longer period

Press "Super Cool" button to activate this function. The super cool icon will be illuminated and the fridge temperature indicator will display 2°C .

- Super cool automatically switches off after 6 hours and the refrigerator temperature setting displays 2°C.
- When super cool function is on you can switch it off by pressing "Super Cool" or "Fridge" button and the refrigerator temperature setting will revert back to the previous setting.

## 5. Super Freeze



Super Freeze can rapidly lower frozen temperature and freeze your food substantially faster than usual

This feature also helps to keep vitamins and nutrition of fresh food for longer period.

- Press "Super Freeze" button to activate the super freeze function. The super freeze light will be illuminated and the freezer temperature setting will display -25°C
- Super freeze automatically switches off after 26 hours .
- When super freeze function is on you can switch off super freeze function by pressing "Super Freeze" or "Freezer" button and the freezer temperature setting will revert back to the previous setting.

**Note:** When selecting the Super Freeze function, ensure there are no bottled or canned drinks (especially carbonated drinks) in the freezer compartment. Bottles and cans may explode.

## 6. Artificial intelligence



When the function is activated, the temperature of the refrigerator is automatically switched to

5°C, the temperature of freezer is automatically switched to -18°C

## 7. Energy Saving



When the function activated, the temperature of refrigerator is automatically switched to 6°C and the

temperature of freezer is automatically switched to -17°C.

## 8. Holiday



When the holiday function is activated, the temperature of the refrigerator is automatically switched to 15°C to minimise the energy consumption.

The temperature of the freezer is automatically switched to -18°C

- **Important!** Do not store any food in the fridge during this time. When the holiday function is on, you can switch it off by pressing any button of "Holiday", "Fridge" and "Super Cool" button. The fridge temperature setting will revert back to the previous setting.

## 9. Mode/Unlock

- You can select different modes by pressing the "Mode/Unlock" button. When certain mode is selected, wait for the corresponding icon flashing for 10 seconds. Buzzer will sound two times afterwards and the icon will be illuminated, which means the setting is completed.
- Each time you press "Mode / Unlock" button, the mode icon will be switched in the following order, Corresponding icon is illuminated.

→ Artificial intelligence--Energy saving  
Holiday--Super cool--Super freezer ←

## 10. LOCK



By pressing "Mode / Unlock" button 5s to switch the locked state, Unlocked or locked.

10. Door alarm

leaving any door open for over 2 minutes will activate a alarm and buzzer, and the control panel will display “ dA ” .

In case of door alarm, buzzer will beep 1 time per minute , and will

automatically stop alarming 8 minutes later .

To save energy, please avoid keeping the door open for a long time when using the appliance.

The door alarm can be cleared by closing the door.

## Using your appliance

Your appliance has the accessories as the "Description of the appliance showed in general, with this part instruction you can have the right way to use them.

### Door basket

- It is suitable for the storage of eggs, canned liquid, bottled drinks and packed food, etc. Do not place too many heavy things in the baskets
- The middle door baskets can be placed at different heights according to your appliance. Please take food out of the baskets before lifting vertically to reposition.

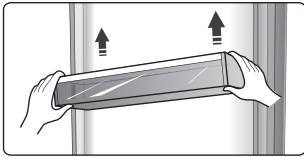

- All the door baskets are completely removable for cleaning.
- Note: There are egg trays in the baskets. Shelf

- There are three glass shelves in refrigerator chamber. They can be adjusted to various heights as needed.

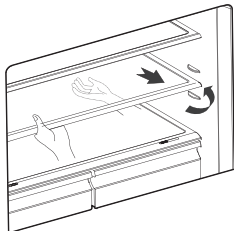

- When you remove the shelves, gently pull them forward until the shelf comes clear of the shelf guides.
- When you return the shelves, make sure there is no obstacle behind and gently push the shelf back into the position.

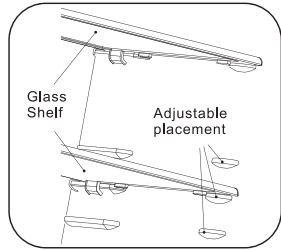

### Crispers

- The crisper, mounted on telescopic extension slides, is for storing vegetables and fruits.

### Crisper cover

- It is for avoiding the vegetable losing moisture. You can adjust the humidity inside the crispers by using the sliding block.

### Crisper and humidity control

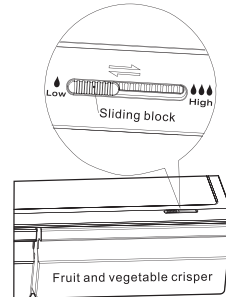

- The humidity control adjusts the airflow in the crisper; higher airflow results in lower humidity. Slide the humidity control to the right in order to increase humidity.
- High humidity settings are recommended for vegetables, while low humidity is suitable for preservation of fruit.

### Using your freezer drawer

●The freezer drawers are suitable for storage of foods required to be frozen, such as meat, ice cream and others.

**Caution!** Ensure that bottles are not stored in the freezer as freezing may cause the bottle to break.

### Using the refrigerator chamber

The refrigerator chamber is suitable for storage of vegetable and fruits. Separate packing of different foods is recommended to avoid losing moisture or flavour permeating into other foods.

#### **Caution!**

Never close doors while the shelves, crisper and/or telescopic slides are extended. It may damage the unit.

●Follow these simple instructions to remove the crisper chamber, or freezer drawer, for cleaning. Empty the crisper chamber; pull it out to fully open position. Lift the crisper from the lateral slides. Push the slides fully in to avoid damage when closing the door.

### Moveable twist ice-maker

●Moveable twist ice-maker is placed in the freezer to make and store ice cubes, you should use it as follows

- 1.Pull out the moveable twist ice-maker from the freezer compartment.
- 2.Fill with drinking water below the maximum level mark.

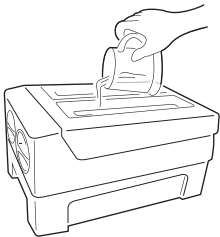

3.Place the filled moveable twist ice-maker back in to the freezer compartment.

4.Await for around 3 hours, twist the knobs clockwise and the ice will drop into the ice box below.

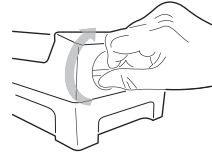

5. Ice cubes can be stored in the ice box until required

**Note:** If the ice tray is used for the first time or has not been used for a long time, please clean it before using.

### Water Dispenser

The water dispenser located in the fridge door, is for storing drinking water. With this appliance you can obtain chilled water easily without opening the refrigerator. You should be informed of following tips.

#### ● Before using

Before using this appliance for the first time, you should use it as follows.

1. Hold one bottom side of the water tank by a hand, lift up the opposite side by the other hand, when the slot of the water tank is off from the guide, change hands to repeat these steps.
2. Hold the two sides of the water tank tightly, lift up and put out of the water tank.
3. Unscrew the head, then clean head, lids and the water tank.

#### **Caution!**

Drain the water tank before you take it down!

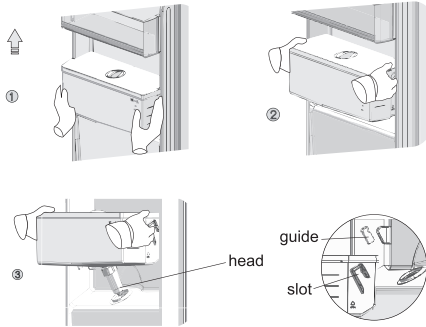

**• Assembling**

After cleaning, please assemble the parts including the head, water tank and lids as follows:

1. Put the seal ring in order first ( the seal ring can not turn up), then insert the head into the hole.
2. Hold the two sides of the water tank tightly, fit the water tank along the guides on the door.
3. Push the two sides of the water tank downward as the picture shows.
4. When you hear clicks by both sides and at the same time the both sides of the water tank is closed to the door liner, It means the installation is completed.

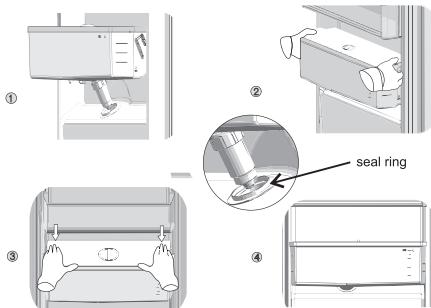

**• Filling water**

Before you fill the drinking water into the water tank, ensure that the water tank is steady and in a correct position.

**Caution!**

Fill with water up to 3.5L ( which is suggested) and not above the level. Otherwise, it may overflow when the lids is closed.

We recommend that you fill the water by the following ways.

- 1.Remove the small lid and fill water from the inlet of the larger lid.
- 2.Remove the cover of the rank, and then fill water inside directly.

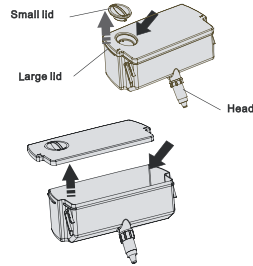

**Warning!**

Don't touch the other parts of the appliance when filling water, it may cause the water leakage.

**•Dispensing water**

- 1.Make sure the cover of the water tank is fitted on.
- 2.Close the fridge door and check the dispenser.

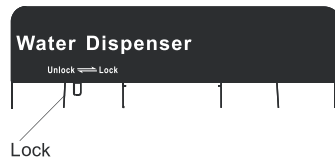

Before you dispense the water, make sure the lock device is on the “Unlock” situation.

**Warning!**

The lock is defined as “child lock”. Don't push the dispenser lever forward strongly, when the dispenser is on “Lock”

situation, it may damage the mechanism.

- **Receiving Water**

You should use the correct cups to receive water underneath the water dispenser.

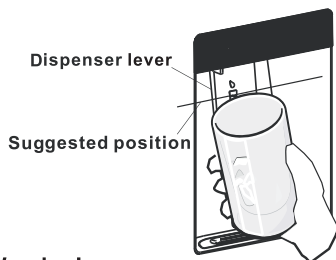

**Warning!**

Don't push the dispenser lever forward without cup, it may cause the water leakage from the dispenser.

**Cleaning**

1.Put the water tank out of the door carefully and then wash the tank, lid, and head lightly in water.

2.After you have successfully cleaned the appliance, you should dry it by natural drying or using the dryer. If you have used the water dispenser for many times, the water in the receiving tank may drop on the floor, which may make your floor wet, and you should clean the tank with dry towel regularly before overflow.

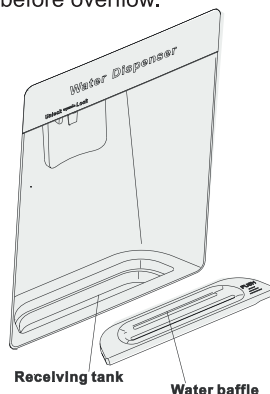



## Helpful hints and tips

### Energy saving tips

We recommend that you follow the tips below to save energy.

- Try to avoid keeping the door open for long periods in order to conserve energy.
- Ensure the appliance is away from any sources of heat. (Direct sunlight, electric oven or cooker etc.)
- Don't set the temperature colder than necessary.
- Don't store warm food or evaporating liquid in the appliance.
- Place the appliance in a well ventilated, humidity free, room. Please refer to Installing your new appliance chapter.
- The diagram shows the correct combination for the drawers, crisper and shelves. Do not adjust the combination as this is designed to be the most energy efficient configuration.

### Hints for fresh food refrigeration

- Do not place hot food directly into the refrigerator, the internal temperature will increase resulting in the compressor having to work harder and will consume more energy.
- Do cover or wrap the food, particularly if it has a strong flavor.
- Place food properly so that air can circulate freely around it.

### Hints for refrigeration

- Meat (All Types) Wrap in polythene food: wrap and place on the glass shelf above the vegetable drawer. Always follow food storage times and use by dates suggested by manufacturers.
- Cooked food, cold dishes, etc.: They should be covered and may be placed on any shelf.
- Fruit and vegetables: They should be stored in the special drawer provided.  
Butter and cheese: Should be wrapped in airtight foil or plastic film wrap.
- Milk bottles: Should have a lid and be stored in the door racks.

### Hints for freezing

- When first starting-up or after a period out of use, let the appliance run at least 2 hours on the higher settings before putting food in the compartment.
- Prepare food in small portions to enable it to be rapidly and completely frozen and to make it possible to subsequently thaw only the quantity required.
- Wrap up the food in aluminum foil or polyethylene food wraps which are airtight.
- Do not allow fresh, unfrozen food to touch the food which is already frozen to avoid partially thawing the frozen food.
- Iced products, if consumed immediately after removal from the freezer compartment, will probably cause frost burns to the skin.
- It is recommended to label and date each frozen package in order to keep track of the storage time.

### Hints for the storage of frozen food

- Ensure that frozen food has been stored correctly by the food retailer.
- Once defrosted, food will deteriorate rapidly and should not be re-frozen. Do not exceed the storage period indicated by the food manufacturer.

### Switching off your appliance

If the appliance needs to be switched off for an extended period, the following steps should be taken prevent mould on the appliance.

1. Remove all food.
2. Remove the power plug from the mains socket.
3. Clean and dry the interior thoroughly.
4. Ensure that all the doors are wedged open slightly to allow air to circulate.

## Cleaning and care

For hygienic reasons the appliance (including exterior and interior accessories) should be cleaned regularly at least every two months.

**Caution!** The appliance must not be connected to the mains during cleaning. Danger of electrical shock! Before cleaning switch the appliance off and remove the plug from the mains socket.

### Exterior cleaning

To maintain good appearance of your appliance, you should clean it regularly.

-Wipe the digital panel and display panel with a clean, soft cloth.

-Spray water onto the cleaning cloth instead of spraying directly on the surface of the appliance. This helps ensure an even distribution of moisture to the surface.

-Clean the doors, handles and cabinet surfaces with a mild detergent and then wiped dry with a soft cloth.

### Caution!

-Don't use sharp objects as they are likely to scratch the surface.

-Don't use Thinner, Car detergent, Clorox, ethereal oil, abrasive cleansers or organic solvent such as Benzene for cleaning. They may damage the surface of the appliance and may cause fire.

### Interior cleaning

You should clean the appliance interior regularly. It will be easier to clean when food stocks are low.

Wipe the inside of the fridge freezer with a weak solution of bicarbonate of soda, and then rinse with warm water using a wrung-out sponge or cloth. Wipe completely dry before replacing the shelves and baskets. Thoroughly dry all surfaces and removable parts.

Although this appliance automatically defrosts, a layer of frost may occur on the refrigerator's interior walls if the door is opened frequently or kept open for too long. If the frost is too thick wait until food stocks are low and proceed as follows:

1.Remove existing food and accessories baskets, unplug the appliance from the mains power and leave the doors open. Ventilate the room thoroughly to accelerate the thawing process.

2.When defrosting is completed, clean your freezer as described above.

**Caution!** Don't use sharp objects to remove frost from the refrigerator. Only after the interior is completely dry should the appliance be switched back on and plugged back into the mains socket.

### Door seal cleaning

Take care to keep door seals clean. Sticky food and drinks can cause seals to stick to the cabinet and tear when you open the door. Wash seal with a mild detergent and warm water. Rinse and dry it thoroughly after cleaning.

**Caution!** Only after the door seals are completely dry should the appliance be powered on.

### Replacing the LED light

Warning: The LED light should not be replaced by the user. If the LED light is faulty, contact the customer helpline for assistance. To replace the LED light, the following steps can be used:

- 1.Unplug your appliance.
- 2.Remove light cover by pushing up and out.
- 3.Hold the LED cover with one hand and pull it with the other hand while pressing the connector latch.
- 4.Replace LED light and snap it correctly in to place.

---

## Troubleshooting

If you experience a problem with your appliance or are concerned that the appliance is not functioning correctly, you can carry out some easy checks before calling for service, please see below. You can carry out some easy checks according to this section before calling for service.

**Warning!** Don't try to repair the appliance yourself. If the problem persists after you have made the checks mentioned below, contact a qualified electrician, authorized service engineer or the shop where you purchased the product.

Problem	Possible cause & Solution
Appliance is not working correctly	Check whether the power cord is plugged into the power outlet properly.
	Check whether the "Power" function is on by pressing the "power" button for 1 second.
	Check the fuse or circuit of your power supply, replace if necessary.
	The ambient temperature is too low. Try setting the chamber temperature to a colder level to solve this problem.
	It is normal that the refrigerator is not operating during the automatic defrost cycle, or for a short time after the appliance is switched on to protect the compressor.
Odours from the compartments	The interior may need to be cleaned.
	Some food, containers or wrapping cause odours.
Noise from the appliance	<p>The sounds below are quite normal:</p> <ul style="list-style-type: none"> <li>● Compressor running noises.</li> <li>● Air movement noise from the small fan motor in the fridge compartment or other compartments.</li> <li>● Gurgling sound similar to water boiling.</li> <li>● Popping noise during automatic defrosting.</li> <li>● Clicking noise before the compressor starts.</li> </ul>
	<p>Other unusual noises are due to the reasons below and may need you to check and take action:</p> <ul style="list-style-type: none"> <li>● The cabinet is not level.</li> <li>● The back of appliance touches the wall.</li> <li>● Bottles or containers fallen or rolling.</li> </ul>
The motor runs continuously	<p>It is normal to frequently hear the sound of the motor, it will need to run more when in following circumstances:</p> <ul style="list-style-type: none"> <li>● Temperature setting is set colder than necessary</li> <li>● A large quantity of warm food has recently been stored within the appliance.</li> <li>● The temperature outside the appliance is too high.</li> <li>● Doors are kept open too long or too often.</li> <li>● After your installing the appliance or it has been switched off for a long time.</li> </ul>
A layer of frost occurs in the compartment	Check that the air outlets are not blocked by food and ensure food is placed within the appliance to allow sufficient ventilation. Ensure that door is fully closed. To remove the frost, please refer to cleaning and care chapter.
Temperature inside is too warm	You may have left the doors open too long or too frequently; or the doors are kept open by some obstacle; or the appliance is located with insufficient clearance at the sides, back or top.

## Disposal of the appliance

It is prohibited to dispose of this appliance as household waste.

### Packaging materials

Packaging materials with the recycle symbol are recyclable. Dispose of the packaging into a suitable waste collection container to recycle it.

### Before disposal of the appliance

1. Pull out the mains plug from the mains socket.
2. Cut off the power cord and discard with the mains plug.

**Warning!** Refrigerators contain refrigerant and gases in the insulation. Refrigerant and gases must be disposed of professionally as they may cause eye injuries or ignition. Ensure that tubing of the refrigerant circuit is not damaged prior to proper disposal.

	Correct Disposal of this product
	<p>This marking indicates that this product should not be disposed with other household wastes throughout the EU. To prevent possible harm to the environment or human health from uncontrolled waste disposal, recycle it responsibly to promote the sustainable reuse of material resources. To return your used device, please use the return and collection systems or contact the retailer where the product was purchased. They can take this product for environmental safe recycling.</p>

**Hisense**

life reimagined